



# ADVANTAGE

ALL ALUMI-GUARD PRODUCTS ARE MANUFACTURED  
WITH PRIDE IN THE UNITED STATES OF AMERICA 

# ADVANTAGE

*"One of The Top Finishing Shops in North America,"  
for four consecutive years!*

~ Products Finishing Magazine



## ALUMI-GUARD®

Our large selection of maintenance-free fence, railing, and gates are made to withstand some of the harshest conditions. Manufactured in a state-of-the-art facility in Brooksville, Florida, Alumi-Guard® products are available in all fifty states and Canada.

Everything we produce - including all panels, posts, and gates - are made right here at home. So know that when you choose an Alumi-Guard product, you're also choosing an American company that manufactures quality, American made products.



ALL ALUMI-GUARD® PRODUCTS ARE  
MANUFACTURED IN THE UNITED STATES OF AMERICA

### SUPERIOR POWDER COATED STRENGTH

Platinum Certified Applicator - Surpasses 10,000 Hours Salt Spray Test  
Meets or Exceeds AAMA 2604-13 Specifications

### CUTTING-EDGE TECHNOLOGY & UNMATCHED SERVICE & SUPPORT

Customer Service, Engineering and Architect Services Departments

### LIMITED LIFETIME WARRANTY



*Protecting what you love*

[ALUMI-GUARD.COM](http://ALUMI-GUARD.COM)

# ADVANTAGES

- U-FRAME GATES
- BEVELED RAILS FOR ADDED STRENGTH
- ECO-CONSCIOUS COMPANY

- EARN LEED POINTS
- CUSTOM SERVICES
- QUICKSHIP COLLECTION PROGRAM

## SIX UNIQUE GRADES

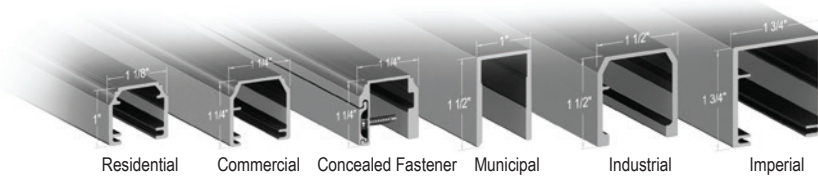

## SEVEN RICH POWDER COATED COLORS

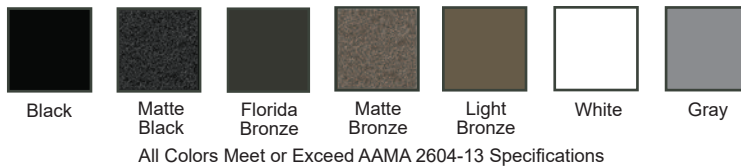

## ALUMI-GUARD® ADVANTAGES

<b>Made in the USA - Available Nationwide</b> Manufactured in a state-of-the art facility located in Brooksville, FL	✓
<b>Platinum Certified Applicator</b> We are a certified applicator for three of the largest international coating manufacturers	✓
<b>Superior Powder Coated Strength</b> Withstands the harshest of conditions Surpasses 10,000 hours Salt Spray Test (ASTM B-117) Meets or exceeds AAMA 2604-13 specifications	✓
<b>Exemplary Service</b> Professional Engineering, Architect, and Customer Service Departments	✓
<b>UL-325 Compliant Gates Available</b>	✓
<b>True Height Panels</b>	✓
<b>Long Product Lifecycle</b> Durable, scratch resistant powder coating, maintenance free, 80% recycled Aluminum - doesn't rust like steel	✓
<b>Seven Rich Powder Coated Colors</b> Standard colors meet or exceed AAMA 2604-13 specifications Custom colors available	✓
<b>Select Sizes Meet ICC Pool Code Specifications</b>	✓
<b>Eco-Conscious Environmentally Aware Company</b> 100% Aluminum, Paper & Plastic Scrap is recycled 90% Evaporant coolant water recycled Less than 1% of powder waste annually Lean Manufacturing Facility Practices	✓
<b>Earn LEED Points (V3)</b> Construction Waste Mgmt, Recycled Content, Innovation in Design	✓
<b>Strong and Durable Boerboel® Hardware</b> Multiple options are available for all gates	✓
<b>Custom Services Available</b>	✓
<b>QuickShip Collection Program</b>	✓

## TABLE OF CONTENTS

About Alumi-Guard®	2
Advantages	3
Flat Top	4
Pressed Spear	5
Premier	6
Enhancements (Radius and Custom)	7
Pedestrian Gates (Walk and Pool)	8
Estate Gates (Swing and Cantilever)	9
Security	10
Chain Link Cantilever	11
Guardrail	12
Handrail	13
Fortress	14
Chariot	15

Please contact us for additional information regarding our powder coating, sealed drawings and load capacities. We're also available for assistance with job specific drawings or custom specifications. If you have questions regarding fencing, gates, balcony style guardrail or ADA handrail, we would be happy to help guide you to the right product for your job.



2401 Corporate Blvd • Brooksville, FL 34604  
Toll Free: 877-258-6448 • Office: 352-754-8555  
Fax: 352-544-8442

# FLAT TOP

## STYLES

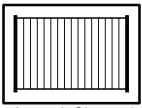

Ascot 2-Channel

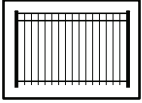

Ascot 3-Channel

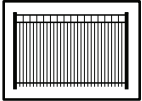

Ascot Royale

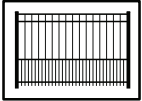

Ascot Puppy-Picket

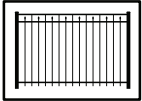

Canterbury

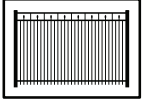

Canterbury Royale

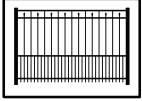

Canterbury Puppy-Picket

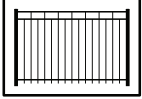

Fairmount

## ASCOT • CANTEBURY • FAIRMOUNT

- Classic and Versatile
- Decorative
- Property Boundary
- 6 Unique Grades
- 7 Rich Colors
- True Height Panels



## GRADES: CHANNELS & PICKETS

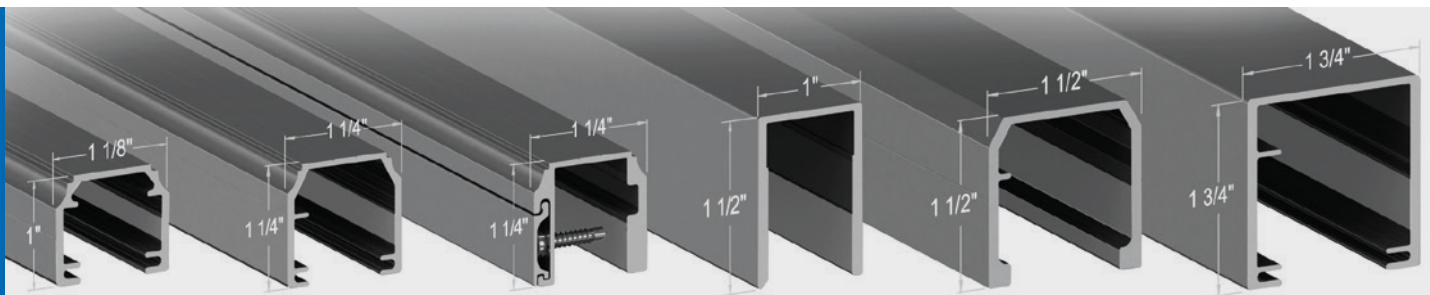

Residential

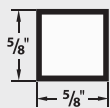

Commercial

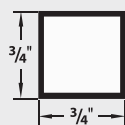

Concealed Fastener

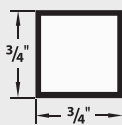

Municipal

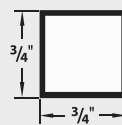

Industrial

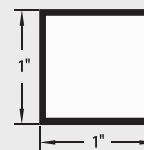

Imperial

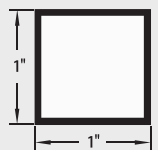

~ Channels & Pickets are shown at 3/5 actual size



# PRESSED SPEAR

## BELMONT • HAMILTON

- Aesthetic Security •
- Decorative •
- Deters Pedestrian Scaling •
- Perfect for Estates •
- 6 Unique Grades •
- 7 Rich Colors •
- True Height Panels •

## STYLES

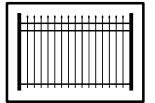

Belmont

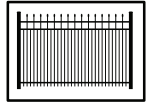

Belmont Royale

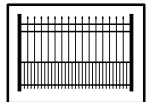

Belmont Puppy-Picket

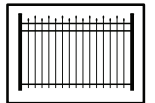

Hamilton

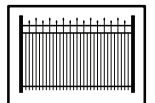

Hamilton Royale

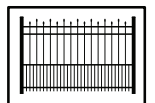

Hamilton Puppy-Picket

## POSTS, ADORNMENTS & COLORS

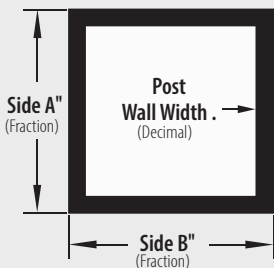

### Post Measurements

2" x 2" x .062"	3" x 3" x .125"
2" x 2" x .093"	4" x 4" x .125"
2" x 2" x .125"	4" x 4" x .250"
2½" x 2½" x .075"	6" x 6" x .125"
2½" x 2½" x .125"	6" x 6" x .250"



~ Custom Colors Available



All Colors Meet or Exceed AAMA 2604-13 Specifications  
 \*Guardrail not available in Matte Black and Matte Bronze



ALUMI-GUARD.COM

# PREMIER

## STYLES

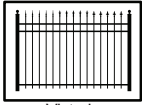

Victoria

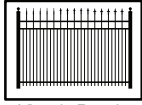

Victoria Royale

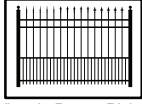

Victoria Puppy Picket

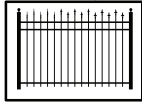

Victoria - Staggered

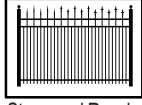

Staggered Royale

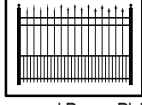

Staggered Puppy Picket

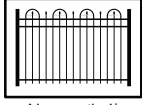

Newcastle I\*

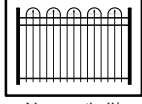

Newcastle II\*

\*Newcastle I & Newcastle II are Available in Residential Grade only.

## VICTORIA NEWCASTLE I & • NEWCASTLE II

- Traditional, Old World Charm
- Decorative Safety Barrier
- Landscape Enhancing
- Ideal for Estates and Homes
- Quad, Triad, or Fleur-de-Lis Finials
- 6 Unique Grades
- 7 Rich Colors



## GRADES: CHANNELS & PICKETS

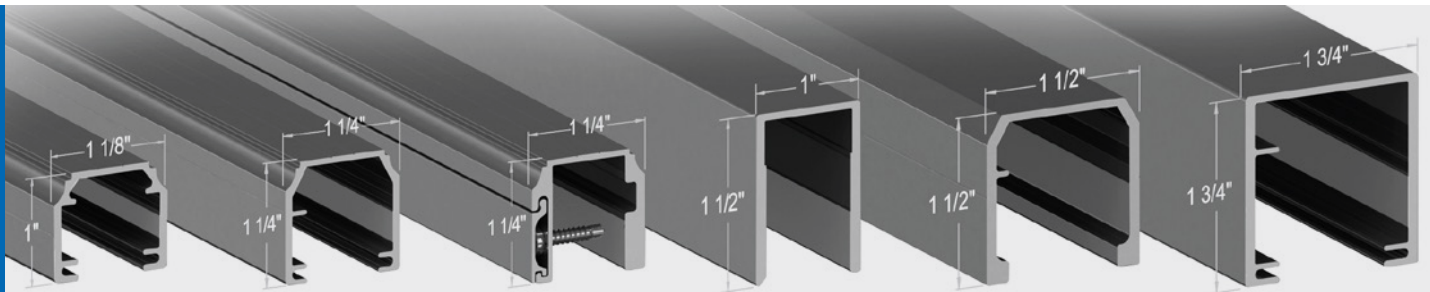

Residential

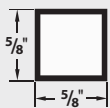

Commercial

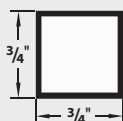

Concealed Fastener

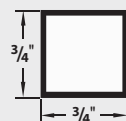

Municipal

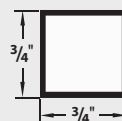

Industrial

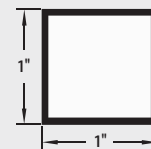

Imperial

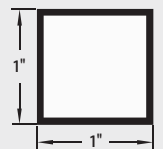

~ Channels & Pickets are shown at 3/5 actual size

# ENHANCEMENTS

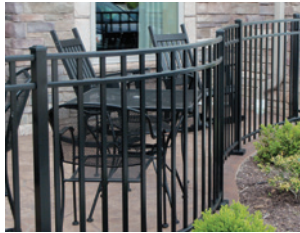

**RADIUS PANEL • CUSTOM SERVICES**

- Custom Services Available •
- Crafted by Skilled Artisans and Engineers •
- Personalized and Individual •
- 6 Unique Grades •
- 7 Rich Colors •
- Custom Colors Available •
- Custom Radius Designs •
- True Height Panels •

## STYLES

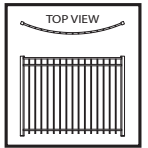

Radius Panels are available in all styles, heights, & Colors\*  
\*Not Available in Concealed Fastener Grade



## POSTS, ADORNMENTS & COLORS

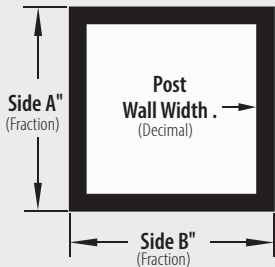

### Post Measurements

2" x 2" x .062"	3" x 3" x .125"
2" x 2" x .093"	4" x 4" x .125"
2" x 2" x .125"	4" x 4" x .250"
2½" x 2½" x .075"	6" x 6" x .125"
2½" x 2½" x .125"	6" x 6" x .250"



~ Custom Colors Available



All Colors Meet or Exceed AAMA 2604-13 Specifications



Protecting what you love

ALUMI-GUARD.COM

# PEDESTRIAN GATES

## ARCHES



Arch 01 Series



Arch 02 Series



Arch 03 Series

## WALK GATES • POOL GATES

- AAMA 2604-13 Compliant
- Powder Coating
- Complements Alumi-Guard® Fence
- Pool Code Latches Available
- Multiple Adornment Options
- 6 Unique Grades
- 7 Rich Colors
- True Height Panels



## GRADES: CHANNELS, PICKETS & POSTS

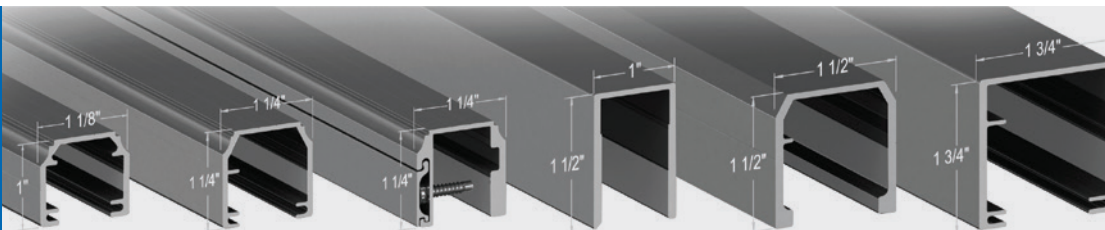

Residential



Commercial



Concealed Fastener

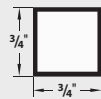

Municipal

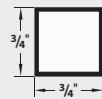

Industrial

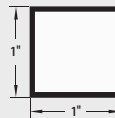

Imperial

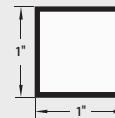

~ Channels & Pickets are shown at 2/5 actual size

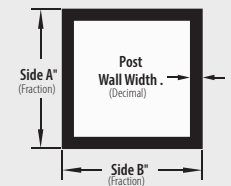

### Post Measurements

2" x 2" x .062"	3" x 3" x .125"
2" x 2" x .093"	4" x 4" x .125"
2" x 2" x .125"	4" x 4" x .250"
2 1/2" x 2 1/2" x .075"	6" x 6" x .125"
2 1/2" x 2 1/2" x .125"	6" x 6" x .250"



# ESTATE GATES

## SWING GATES • CANTILEVER GATES

- Impressive, Elegant Functionality •
- Complements Alumi-Guard® Fence •
- Hardware Included •
- Upgraded Hardware Available •
- Custom Gate Options •
- 6 Unique Grades\* •
- 7 Rich Colors •
- Beveled Rails For Strength •

## ARCHES

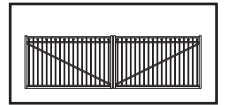

Arch 01 Series

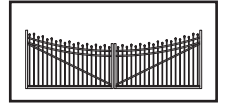

Arch 02 Series



Arch 03 Series

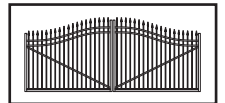

Arch 04 Series

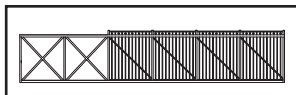

Arch 01 Series

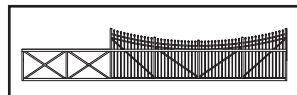

Arch 02 Series

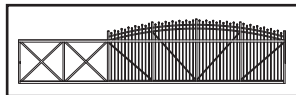

Arch 03 Series

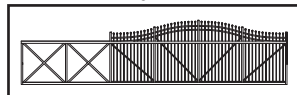

Arch 04 Series

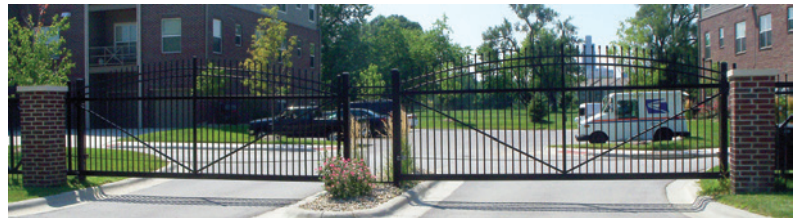

## HARDWARE & COLORS

### Featuring Strong and Durable Boerboel® Hardware

Multiple options are available for all gates in addition to the selection shown below



**BOERBOEL®**  
Gate Solutions



Wrap Hinge



GardDog® Locking Pool Latch



Butterfly Hinge



Gate Stop

~ Custom Colors Available



Black



Matte Black



Florida Bronze



Matte Bronze



Light Bronze



White



Gray

All Colors Meet or Exceed AAMA 2604-13 Specifications  
\*Sliding Cantilever or V-Groove Gates are available in all styles of Commercial, Municipal, Industrial and Imperial Grade Fence.

T-Slot Post attachment method eliminates unsightly u-bolts and bolt-throughs.

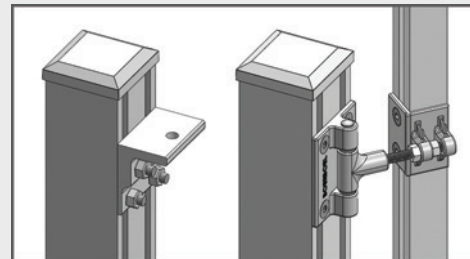

Protecting what you love

[ALUMI-GUARD.COM](http://ALUMI-GUARD.COM)

# SECURITY

## STYLES

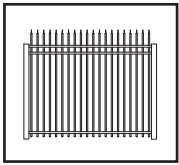

3 Channel

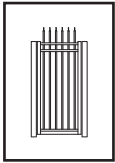

3 Channel  
U-Frame Gate

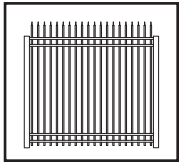

4 Channel

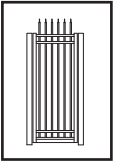

4 Channel  
U-Frame Gate

## 3 & 4 CHANNEL STYLES MULTIPLE HEIGHTS & PANEL SIZES

- Achieves a High Level of Security
- Deterrent to Trespassers
- Industrial and Commercial Applications
- One of Our Heaviest Grades
- Withstands Above-Normal Abuse
- 7 Rich Colors
- U-Frame Gates
- Beveled Rails For Strength
- True Height Panels



## GRADE: CHANNELS, PICKETS, POSTS & ADORNMENTS

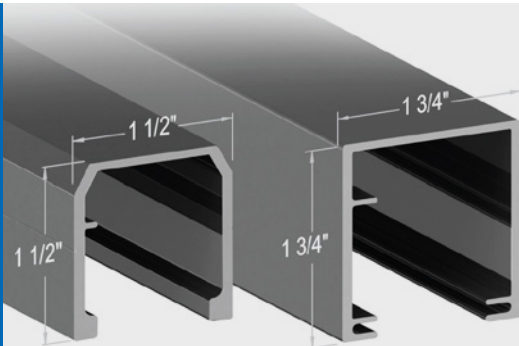

Security Grade

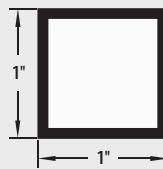

Security Picket

### Post Measurements

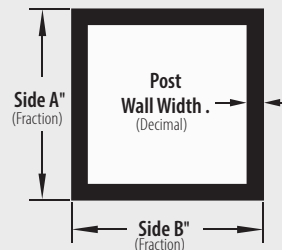

2½" x 2½" x .075"	4" x 4" x .125"
2½" x 2½" x .125"	4" x 4" x .250"
3" x 3" x .125"	6" x 6" x .125"
	6" x 6" x .250"



Security Grade Pressed Spear (Standard) Standard Post Cap

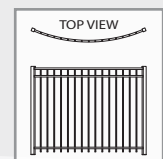

Radius Panel is Available in Security Grade

- ~ Security Grade comes standard with Industrial Grade channel. Imperial Grade channel is available as an upgrade.
- ~ Security Channel and Picket are shown at 3/5 actual size. Post image is a representation only.



# CHAIN LINK CANTILEVER

## SINGLE OR DOUBLE TRACK MULTIPLE HEIGHTS & LENGTHS

- Adds a High Level of Security
- Deters Trespassers
- Industrial and Commercial Applications
- Strong, Hand-Crafted Framework
- Chain Link, Wood, and Vinyl Inserts
- Optional Barbed Wire Top
- Superior Powder Coating Strength
- UL-325 Gates Available
- Multiple Track Options and Sizes
- 7 Rich Colors

## STYLE EXAMPLES

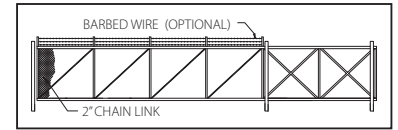

288" Cantilever • 6' Chain Link

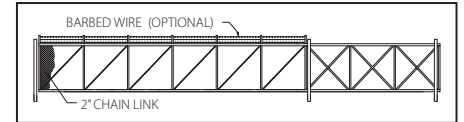

384" Cantilever • 6' Chain Link



## DETAILS & COLORS

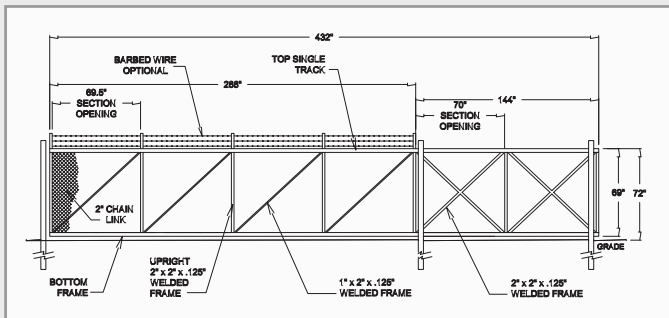

Chain Link Cantilever Gate  
(Detailed Example)

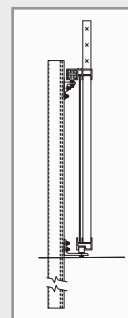

Track & Trolley  
Assembly  
(Single)

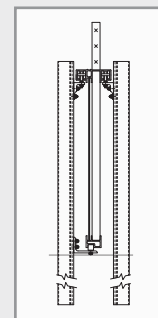

Track & Trolley  
Assembly  
(Double)

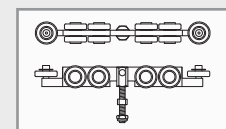

Detail - Trolley Assembly



Black    Matte Black    Florida Bronze    Matte Bronze    Light Bronze    White    Gray

All Colors Meet or Exceed AAMA 2604-13 Specifications



Protecting what you love

ALUMI-GUARD.COM

# GUARDRAIL

## COMPONENTS

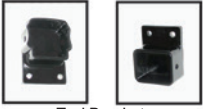

End Brackets



2 1/2" Intermediate Bracket



Vertical Swivel



Horizontal Swivel



Ball & Socket Swivel Bracket 2 1/2" - WRAP



Ball & Socket Swivel Bracket FLAT



Decorative End Cap



Bottom Rail Insert



2" & 2 1/2" Side Mount Flanges



- Complements a Variety of Architectural Styles
- Commercial and Residential Applications
- Meets Strict Safety Codes in All 50 States
- Can be Configured to Meet the 45" Spacing Required by ICC Pool Code
- Durable and Easy to Install
- Available in Multiple Heights
- Optional Adornments
- 5 Rich Colors



## POSTS, PICKET & DETAILS

End Post  
2 1/2" x 2 1/2" x .125"

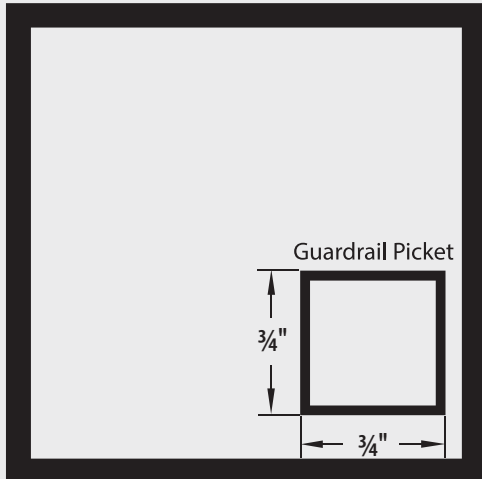

Guardrail Picket

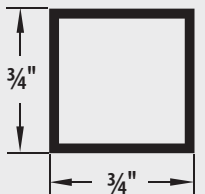

Guardrail Channels & Fasteners

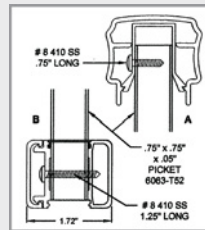

Intermediate Bracket

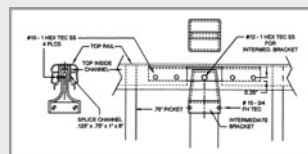

Guardrail Details

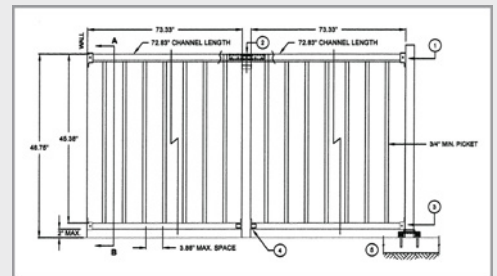

~ Railing Posts & Picket are shown actual size.



# CHARIOT

## TWO RAIL • THREE RAIL • FOUR RAIL

- Reminiscent of the Old Split-Rail Fence •
- Functional, Elegant and Simplistic •
- Excellent for Livestock Containment •
- Boundary Definition with a "Rural" Feel •
- Unobstructed View of Property •
- Superior Powder Coated Strength •
- 3 Styles Available in 8' Sections •
- 7 Rich, Long-Lasting Colors •
- Beveled Rails For Added Strength •

## STYLES

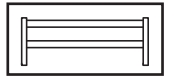

Chariot 2-Rail

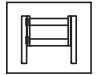

2-Rail Gate

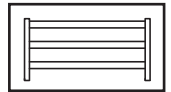

Chariot 3-Rail

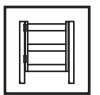

3-Rail Gate

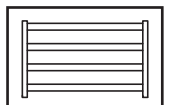

Chariot 4-Rail

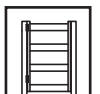

4-Rail Gate



## CHARIOT RAIL, POST & COLORS

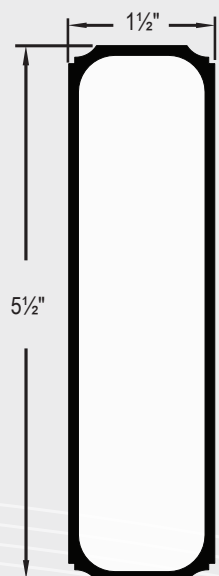

Chariot Horizontal Rail

Chariot Post  
4" x 4"

## COLORS



All Colors Meet or Exceed AAMA 2604-13 Specifications

Chariot Horizontal Rail & Chariot Post are shown at approximately 1/2 actual size



Protecting what you love

ALUMI-GUARD.COM

ALUMI-GUARD.COM



Industrial Grade • Belmont  
Four Channel • White



Protecting what you love

Your Local Authorized Alumi-Guard Dealer

ALUMI-GUARD.COM



AMERICAN SOCIETY OF  
LANDSCAPE ARCHITECTS  
FLORIDA CHAPTER



Member of the  
American Fence Association



The Construction  
Specifications Institute



North  
American  
Fence  
Contractors  
Association